









iAMC1200

FALCON SERIES

KEY FEATURES

-  Lightweight and High-power density
-  Industrial – Strength, Longevity, and Safety
-  100% tested with individual performance reports
-  Self-cooling by design
-  Power pull back
-  ePConnected[™] - Real Time Data Monitoring (RTDM)
-  CAN & PWM enabled

DATASHEET

Fly Higher. Fly Longer. Fly Smarter.

Uncrewed aerial vehicle (UAV) electronics have evolved to meet more demanding mission requirements. More intelligent energy supply and controller designs continually improve on efficiency, ensure reliability, reduce weight, minimize heat dissipation, and lower cost. The greater levels of energy and performance efficiencies delivered in the high-power Falcon iAMC1200 meets the most stringent payload demands and UAV design requirements.

Intelligent Air Motor Controller

This USA-made ePropelled intelligent Air Motor Controller (iAMC1200) or electronic speed controller (ESC), works alone or alongside our powerful Falcon propulsion motors (PMs). Together, they create a high-performance, high-efficiency propulsion solution for your demanding UAV designs.

The iAMC1200 transforms DC input voltage into a 3-phase AC output voltage and acts as the brain of the PM. iAMC1200s deliver sensorless Field Oriented Control (FOC), detecting minute changes in the PM's direction, acceleration, and other variables to automatically adjust for optimized stability and precise flight control.



iAMC1200 TECHNICAL SPECIFICATIONS

PARAMETER	VALUES/DETAILS
Input voltage range	(12S Lixx0) - (24S Lixx0)
Motor compatibility	Brushless, sensorless
Output phase current (30 s)	350Apk [248 Arms]
Output phase current (180 s)	300Apk [212 Arms]
Output phase current (continuous)	175Apk [124 Arms]
Input voltage	84 VDC 96 VDC
Anti spark protection	Yes
Peak output power (30 s)	15,000 W
Peak output power (180 s)	12,000 W
Continuous output power	6,000 W
Efficiency	up to 98%
Inverter switching frequency	40 kHz, 50 kHz
Advance angle control	0°, 10°, 20°, 30°, 40°
Maximum electrical frequency	2.67 kHz
Ambient temperature range	0°C to 40°C (32°F to 104°F)
Maximum internal inverter temperature	100°C (212°F)
Motor temperature measurement	Yes
Motor temperature protection	Yes
Power connection	2 X M8 screw terminal
Motor lead	3 X M8 screw terminal
Communication	CAN 2.0a
Speed commands	PWM or CAN command via eP Connect
Real-time data monitoring (RTDM)	Yes (10 data points with speed, current and temperatures)
IP rating	IP20
Cooling air flow for operation without fan	5 m/s
CAN connector	DB15-HD
Speed command connector	DB15-HD
Weight	1,950 g
Dimension (L x W x H)	180 mm x 190 mm x 91.5 mm
Configurable parameters	24 parameters covering system, motor, inverter, PWM input & alert thresholds
Alerts via CAN bus	Alerts covering 18 conditions
Multiple iAMCs can be used on the same CAN bus	Yes, up to 15 devices

Notes:

- Lixx0 = LiFePo4 or
- LiPoE&OE

MECHANICAL DIMENSIONS

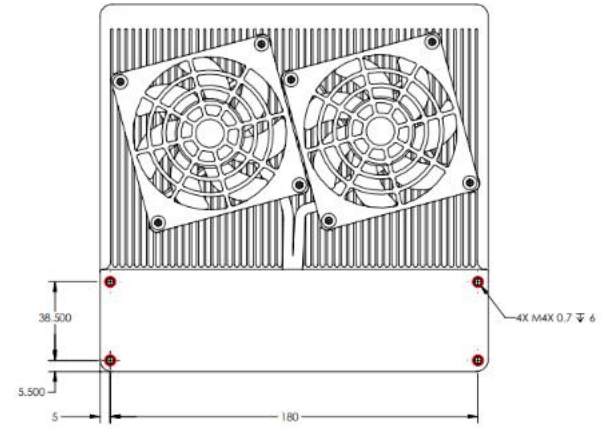
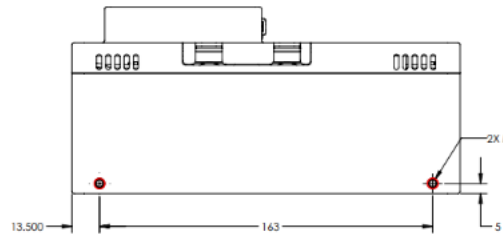
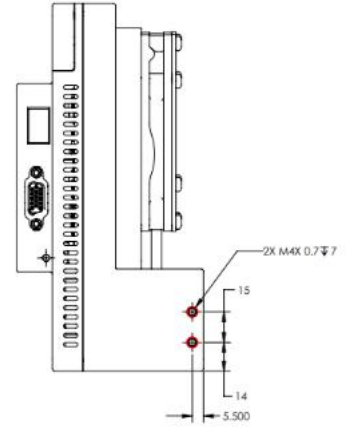
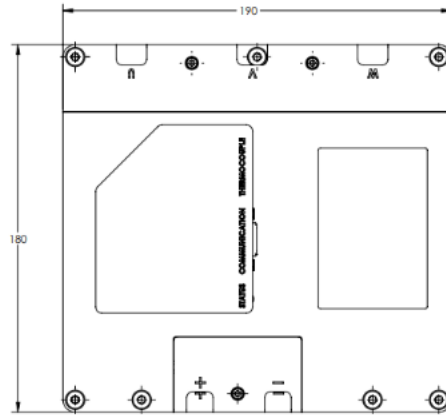
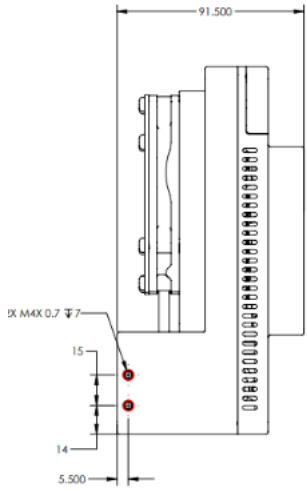

*All Dimensions are in mm. Mounting holes are marked in red.

iAMC1200 PINOUT

Connector Type	Pin Name	Pin Description
Power (M8 screw terminals)	U	U phase input connection for PM
	V	V phase input connection for PM
	W	W phase input connection for PM
	+	Positive input connection DC supply/battery
	-	Negative input connection DC supply/battery

iAMC1200 V1 PINOUT

DB15 Pin	Pin Name
1	Not used. Do not connect
2	Not used. Do not connect
3	Not used. Do not connect
4	GND
5	CANH
6	Not used. Do not connect
7	Not used. Do not connect
8	Not used. Do not connect
9	Not used. Do not connect
10	CANL
11	TMS
12	TCK
13	Not used. Do not connect
14	Not used. Do not connect
15	PPM/PWM Input
Chas	GND

iAMC1200 V1 K-TYPE THERMOCOUPLE INPUT

TC	Pin Name
+	Positive TC input
-	Negative TC input



Note: All specifications are subject to change without notice. For more information, including ordering products, please contact us at info@epropelled.com | Phone: +1 (603) 236 7444