









iPS750

HERCULES SERIES

KEY FEATURES

-  One primary output (28 V) and two adjustable secondary outputs (12 V-14 V and 5 V-8 V)
-  LED indicators provide status for each output voltage and current
-  Overcurrent and short circuit protection
-  Real Time Data Monitoring (RTDM)
-  Configurable EES parameters for different internal combustion engines
-  High efficiencies of up to 93.5%, load dependent
-  Onboard battery charging

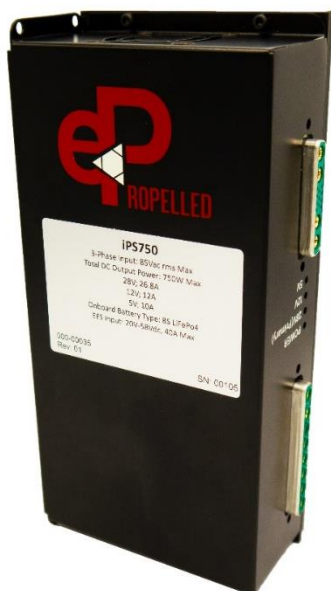

DATASHEET

Fly Higher. Fly Longer. Fly Smarter.

Uncrewed aerial vehicle (UAV) electronics have evolved to meet more demanding and varied mission requirements. More intelligent power management improves efficiency, expands mission options, reduces size/weight, and lowers total costs. The intelligent and integrated power electronics in the sophisticated Hercules iPS750 meets the most stringent demands and UAV design requirements.

Intelligent Power Systems

ePropelled intelligent power systems (iPS) provide a comprehensive power management solution for aviation by converting 3-phase sinusoidal AC from a starter generator into tightly regulated DC for onboard avionics, servos, and various other payloads. Designed to handle varying input voltages, the Hercules iPS750 uses active rectification and switching regulation to ensure a steady DC output. It continuously monitors input and output voltages, as well as current levels, and reports this data via a CAN interface. Custom applications and alert thresholds can be configured through an open API. The system also supplies onshore DC power for functions including EES, output power, and battery charging.

Additionally, the iPS750 features an optional electronic engine starter (EES) that aids in driving the starter generator during engine start-up, switching to regulated voltage once the engine reaches operational speed. If the starter generator fails, an onboard battery (if installed) provides temporary power based on its size, ensuring reliable operation and system integrity.



Battery Features

- The onboard battery can provide power to outputs if 3-phase generator power is lost
- The onboard battery is charged when the unit is connected to 3-phase power or onshore DC power
- The onboard battery can be used to power the EES function
- Onshore DC power for all features including EES function, output power, and onboard battery charging

Temperatures Monitored and Logged

- Synchronous rectifier FETs
- DC Converter FETs
- Output or Input FETs

User-Configurable Parameters

- Conductor compensation voltage boost
- Alert and Threshold Settings
- RTDM Settings
- CAN bus Settings

Mounting Instructions

The figure below depicts the overall dimensions of the iPS chassis. Four holes are used for mounting the unit. Please note that weight and other details are provided in the technical specification table.

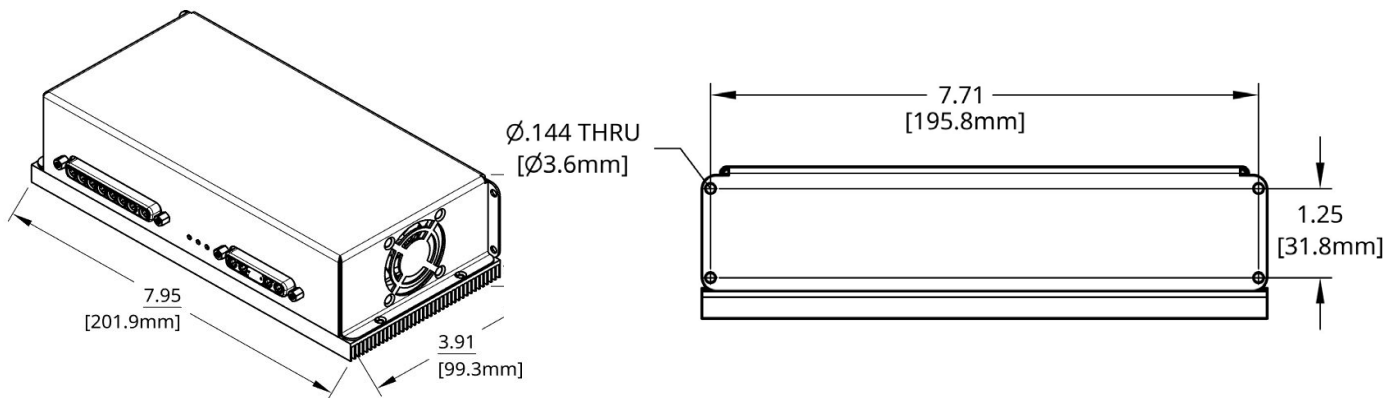

iPS750 TECHNICAL SPECIFICATIONS

iPS750 SPECIFICATIONS			
Parameter	INPUT		
	Min	Max	Notes
Input voltage range	25 V @ no load 50 V @ full loads	85 V	RMS line-to-line
Maximum total input power	831 W		50°C ambient, minimum recommended 4 m/s airflow across the heat sink
Onboard battery voltage range	24 V	28 V	Battery type: 8S LiFePo4 or 7S LiPo
Onshore DC voltage range	24 V	58 V	Input voltage below 33 V will not regulate the primary output. Max Continuous Current: 10A
Engine starter voltage range*	24 V	58 V	Supplied from onshore DC or onboard battery
Engine starter's current range	0 A	40 A	At 28 VDC, open loop 40 A peak /phase
Start trigger voltage	2.3 V	5 V	
Start Duration	0.25 s	10 s	5 seconds between attempts
Parameter	OUTPUT		
	Value		Notes
Maximum total output power (continuous)	750 W		DC at 50°C ambient, minimum recommended 4m/s airflow across the heat sink
Primary output voltage	28 V		DC, max power = 750 W (26.8 A at 28 V)
Secondary output voltage 1	12 V	14 V	DC, max current = 12 A
Secondary output voltage 2	5 V	8 V	DC, max current = 10 A
Voltage regulation	±500 mV		
Voltage ripple P-P	500 mV		
Peak efficiency	93.5%		At 60% full load
Onboard battery charging voltage	29.2 V		Float voltage (8S LiFePo4 or 7S LiPo)
Onboard battery charging current	1.67 A		Max
Protection	Input undervoltage warning Output overvoltage warning *Output short circuit protection Output overcurrent protection Over temperature Warning Onboard battery switchover		
Dimensions	201.9 mm x 99.3 mm x 54.0 mm		
Weight	780g		
Cooling	Fan cooled		
Ambient operating temperature	-26°F(-32°C) to 122°F (50°C) at 750 W. Cranking an engine that is cold (<20°C) may require additional torque that exceeds the capabilities of the iPS750.		
Storage temperature	-40°F (-40°C) to 185°F (85°C)		
Ingress protection	IP20		

*Depending on the characteristics of the engine, the effective engine starter voltage range may be in a narrower range than specified. This value is only provided as an indication of the range possible and will be dependent on the specific internal combustion engine (ICE) the customer has specified.

⚠ ***WARNING:** When operating without an onboard battery, the unit has output short circuit protection. However, if a battery or a power supply is connected to the onboard battery terminals, the short circuit protection will force the unit into a switchover state when the output is shorted. **This will cause damage to the circuit that is responsible for handling the switchover and it will void the warranty.**

⚠ ***WARNING:** The onboard battery must be fused with a **30 A fast blow in-line fuse**. Failure to add the specified in-line fuse will result in damage to the unit and void the warranty.

Derating with Increased Altitude

The derating factor for altitude is based on the loss of dielectric strength of the air as the density decreases with the altitude. The diagram below shows how the cooling efficiency changes with high altitude and ambient temperatures.

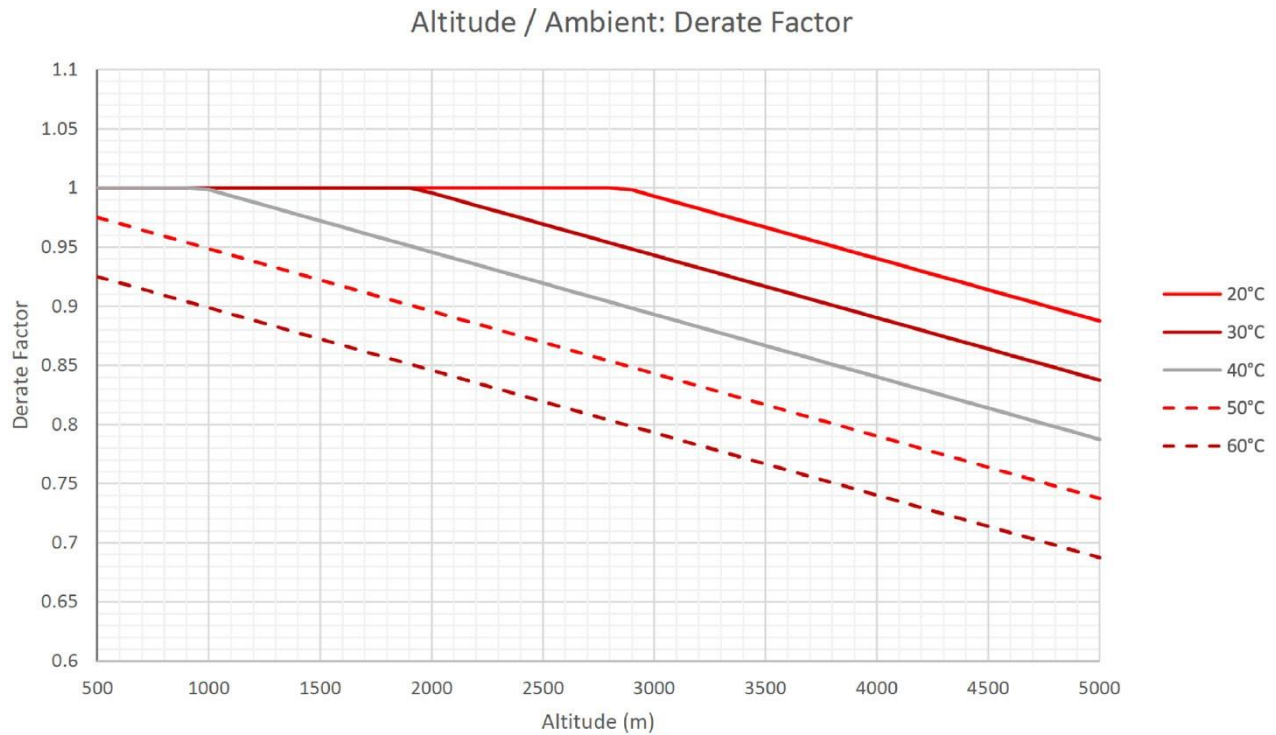

Recommended Applications

- Aircraft power systems
- Unmanned vehicle power systems
- Power conditioning
- Stand-alone power systems (SAPS) for remote area power supply
- Voltage regulation in the renewable power generation system

iPS750 PINOUT

INPUT CONNECTOR
 (mates with 681-00004)

Pin	Label
A1	NOT USED
A2	Onboard battery+
A3	GND
A4	U-LEG
A5	V-LEG
A6	W-LEG
A7	GND
A8	Onshore DC+

OUTPUT/SIGNAL CONNECTOR
 (mates with 681-00005)

Name	Description
A1	+12V
A2	GND
A3	+28V
A4	GND
1-2	+5V
3-4	GND
5	START, ENABLE*
6	START, INPUT
7	BB SIGNAL, OUTPUT
8	GND
9	BAT 10K NTC**
10	CAN+
11	CAN-



Note: All specifications are subject to change without notice. For more information, including ordering products, please contact us at info@epropelled.com | Phone: +1 (603) 236 7444